

A new insect-trap.

By

RENÉ MALAISE,
Stockholm 50.

Since the time of Linnæus the technique of catching insects has not improved very much, and we are to-day using the same kind of net as then for our main instrument. It is true that this net to-day is lighter and possible to fold up and stow away when not in use, but the idea is the same, and the catching abilities of our nets are not superior to those of Linnæus. It is also rather probable that those early naturalists had different types of nets for use in the air, among shrubs, and in the water.

Some insects are attracted to light, others to different kinds of bait — methods also known of old. Our lights are stronger, but we use practically the same kinds of bait, and the methods have not changed. The only outstanding improvement in the catching technique is the sift, especially in connection with the apparatus of Berlese. What the sifting means to the coleopterist or to any student of minute earth-insects cannot be overestimated. Unfortunately this method can only be used for the fauna living in earth, decaying wood, among old leaves, or other such localities on or near the ground, but to improve our knowledge of the overwhelming multitude of insects flying during the daytime, and of those not to be attracted by light or baits, we have to rely on our nets. In the hand of an expert collector a net can work wonders, but however swift he may be, the very act of sweeping and the subsequent attempt to persuade or force the caught insect into the killing-bottle will always require a certain amount of time, and time is always precious. Every collector has certainly experienced the maddening sight of a most desirable insect leisurely passing close by, when both his hands were busy catching a more common insect with the bottle from inside the netting.

During my extensive travels I have repeatedly found that insects happened to enter my tent, and that they always accumulated at the ceiling-corners in vain efforts to escape at that place without paying any attention to the open tent-door. On

one occasion one of the upper tent-corners happened to have a small hole torn in the fabric, and through this hole all the insects pressed their way and escaped. Later on the idea occurred to me, that, if insects could enter a tent and not find their way out, and always persistently tried to reach the ceiling, a trap, made as invisible as possible and put up at a place where insects are wont to patrol back and forth, might catch them much better than any tent and perhaps better than a man with a net, as a trap could catch all the time, by night as well as by day, and never be forced to quit catching when it was best because dinner-time was at hand. When preparing for an entomological expedition to Burma my

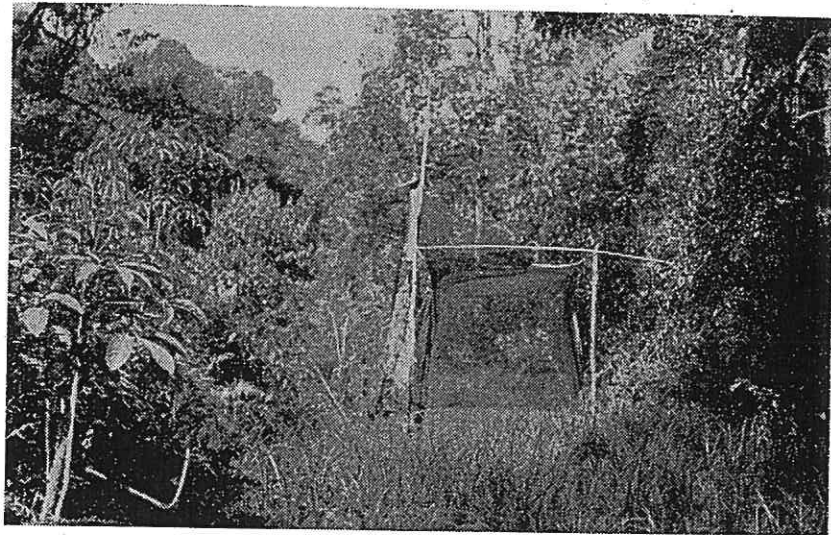

Fig. 1. The trap pitched across a swampy rivulet near Kambaiti in Burma. The trap is seen from behind.

idea took definite shape; and three weeks before the departure to Burma I managed to construct the first trap.

This first trap consisted of a modified fish-trap of black cotton-net (Fig. 1, 2, and 3), and of a brass cylinder (Fig. 4), where the insects caught were killed. The first part was made by a tailoress according to my design: the cylinder I made myself. The season prevented the trap being tried out first. From material brought along, the net-part of the trap was copied in Rangoon by native tailors, and I was able to start with five. On board the steamer I had made two more cylinders: the remaining two I expected to have made in Rangoon, but no tinsmith would consent to undertake this novel kind of work.

One of the traps was put up at a fairly good place near the Burma-Yünnan frontier. It was a thrilling experience to examine the result after the first day, and the success was unquestion-

able. As the weather of the early spring in the break of the monsoon gradually grew warmer, and new and better places for the traps were found; every day's catch from the traps grew larger and larger, and sorting it required more and more time.

It was a great handicap that only three cylinders were available, and I tried to replace the cylinder by an ordinary insectnet (Fig. 2) but most insects that remained in it were torn, especially the *Lepidoptera*; and several insects ate their way out through the

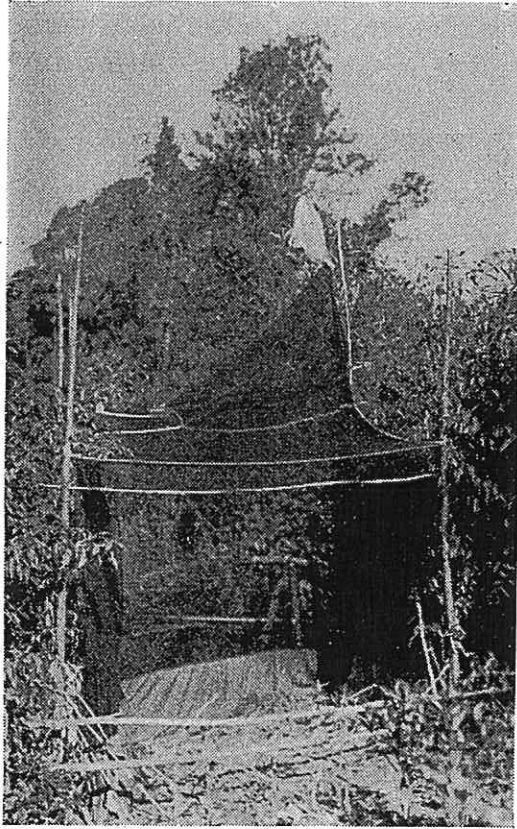

Fig. 2. Frontal view of the trap. Owing to shortage of cylinders, this is replaced by an ordinary insectnet.

netting fabric, so that after a few days the net was rendered useless. During some rainy days I made in the field a fourth cylinder, and I greatly regretted not having brought more brass-tin along for the fifth one.

The chief difficulty in using this trap is to find a suitable place. A trap put up in an open field would doubtless catch insects too, but the number of insects passing that special spot is a restricted one compared with a place where they are for some reason or other concentrated. Such concentrations are not uncommon; the insects are, e.g., more numerous along the border of a wood or field than in the middle of it. Most, if not all, flying insects have an instinctive fear of being blown away by the wind, and are therefore always trying to keep against it, thereby taking advantage of depressions and other irregularities of the

earth's surface, that will furnish them shelter or help them in advancing against the current. Stronger insects are not so dependent on shelter, but have nevertheless a special liking for streamlets, ravines, shores, wood-fringes, forest-roads, clearings, etc. where they patrol back and forth. Weak fliers very often prefer such openings to the dense wood. Such places are as a rule very good for traps, which must be expanded at right angles to the main direction, and preferably with the entrance away from the prevailing wind, so that insects working their way against the current may enter the trap. On pass-points or other such places

where a more or less strong wind is blowing, it is advantageous to place some low shrubs inside the trap or just outside the main net-wall, as the insects will use the back-current and shelter of the shrub to work their way into the trap close to the ground, and, finding the netting easy to climb, they will proceed straight into the smaller apartment.

During my stay at Kambaiti in N. E. Burma, I found that the valley was somewhat contracted and bent about a mile above the village and there along the road to the Chinese frontier-pass the insects were concentrated in a remarkable way. One by one, I

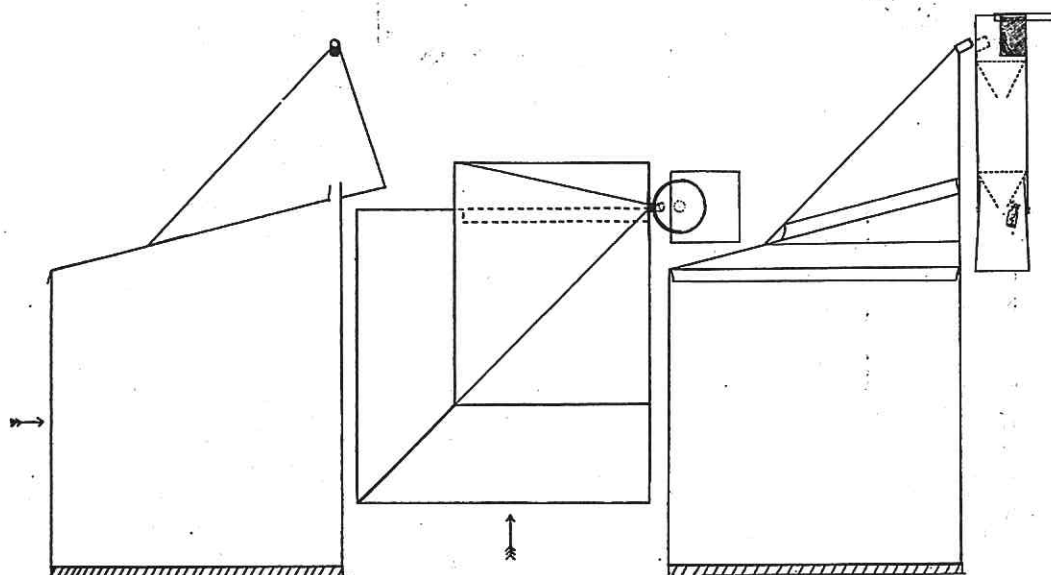

Fig. 3. The original trap, a) From the side. b) From above. c) From in front. The arrow shows the entrance. The cylinder is drawn to twice the scale of a trap.

removed my traps from other places to put them up again here in line one behind the other at intervals of 10 to 50 metres, and still the catch increased.

The construction of the trap is easy to understand from the sketch (Fig. 3). The lower part consists of a large cube of black cotton netting $2 \times 2 \times 2$ yards, with one side and the floor missing. The ceiling is obliquely raised to one of the hind corners. Along the hind or main wall is a four inch broad split in the ceiling, which split constitutes the opening to the upper compartment. This latter is in the form of a pyramid with the apex at one side and in the prolongation of the highest lateral wall of the main cube. From the apex of the pyramid a brass tube sewn into cloth leads to the metal cylinder in which the insects are killed. The sides of the split at the bottom of the pyramid are elevated, and the

pyramid itself extends outside the main cube in order to prevent the insects from finding their way back from the smaller compartment. The brass tube is cut along its length, so that it may be compressed when inserted into the opening of the cylinder, and, when released expand and fit tightly.

All corners of the trap are provided with loops for attaching the trap to poles or trees. Close to the ground all sides of the

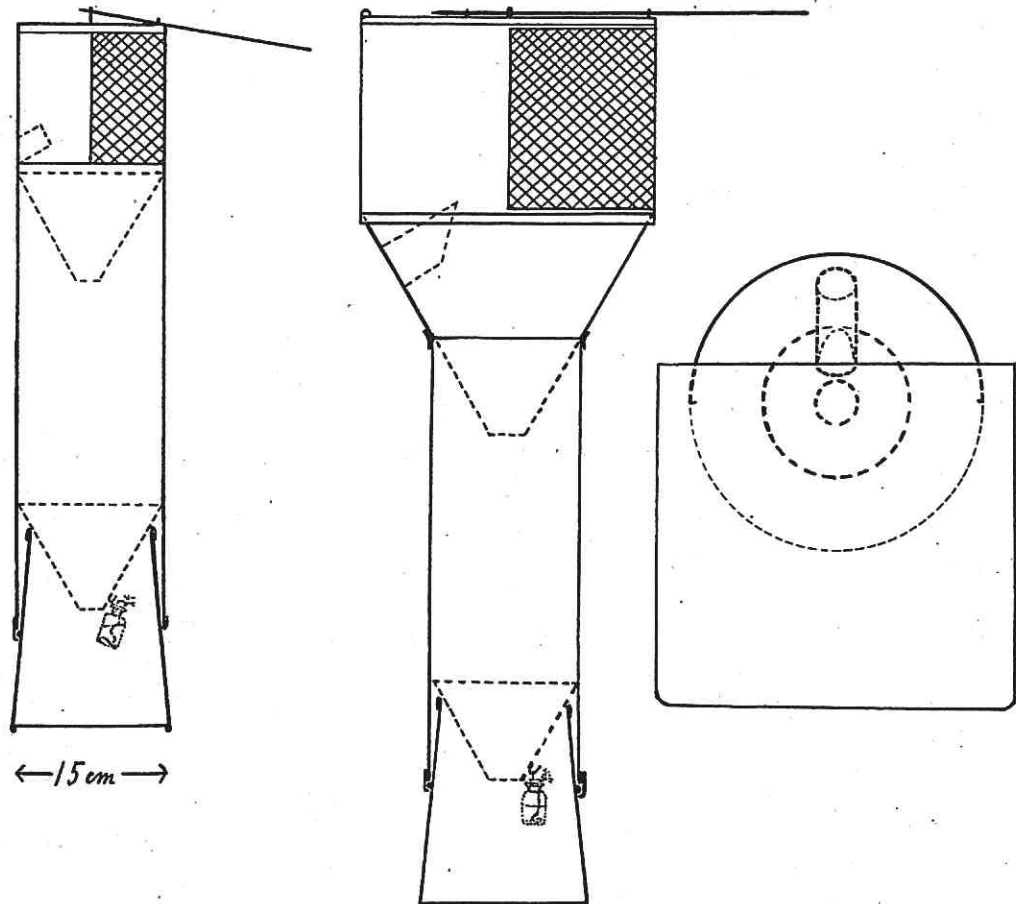

Fig. 4. The cylinder. a) The old model. b) The new model. c) The latter from above.

With the larger entrance the upper compartment of the cylinder had to be made larger.

netting are prolonged by a brim of plain, cheap material about one yard wide. When the trap is pitched, this brim is partly on the ground, burdened with stones or other weights to prevent beetles and other insects that have let themselves fall to the ground from crawling under the netting and escaping. Owing to the humidity near the ground, this part will quickly decay, and must therefore be substitutable. On even ground this brim will raise the trap considerably and in broken country it will compensate for the slope.

The cylinder (Fig. 4) has three compartments, the floor of the two upper ones are funnel-shaped with a hole at the bottom. The third compartment is removable and the bottom of it is flat. From the underside of the second funnel, which acts as the ceiling of the third compartment, a bottle with acetic ether is hung, and the cork of the bottle has a wick passing through a slit in it. The evaporating acetic ether will fill the third compartment with poisonous gas which will kill any insect entering. The second compartment is not strictly necessary, but it is essential that the gases should not come up into the first compartment in too large quantities, lest the smell of it should warn the insects not to enter. With a long distance and two small holes to pass, no more gas will rise up than will diffuse away through the netting window. Above the permanent top-cover of the cylinder is another removable one for protection against rain.

An insect entering the trap through the opening will find its way barred by the main wall, and in most instances the insect will try to pass over the obstacle, and accordingly follow the wall upwards. If it then misses the opening to the second compartment, the first sign of alarm is usually shown when the ceiling prevents its further advance upwards. Usually the insects then drop down, but rarely more than half a metre before the ascent is repeated. After a few turns they try to follow the edge of the ceiling, and as this is oblique they follow it upwards and thereby reach the entrance to the inner chamber. Here they feel themselves trapped in earnest, and will penetrate into every corner in search of an escape, and sooner or later pass into the cylinder. The light from the sky visible through the brass netting will entice them to brave the smell of the acetic ether and enter to the cylinder.

The insect entering will try to escape through the netting window towards the light, but sooner or later it will drop down and slide through the opening of the first funnel. Most insects are in the habit of dropping to the ground in order to get out of a precarious situation, and, if they do not voluntarily drop, the intoxicating gases, although diluted in the upper apartment, will cause them to fall down. Once through the opening of the funnel, they are hardly able to return, as they usually drop through the next funnel too, and once in the third apartment, with the concentrated gases, they succumb almost instantaneously.

It is advantageous to empty the cylinder once a day; in dry climates every morning and evening, but in very humid climates it is possible to let the trap stand unattended for up to a week at a time without risk of the catch of the first days being spoiled. The acetic ether will protect the dead insects from mould, and the only risk is that the antennae of those first caught may be

come brittle and be broken by insects entering later, or when the cylinder is emptied. In a dry climate it ought to be possible to lessen this risk by suspending a second bottle with water beside the one with acetic ether.

The use of acetic ether has many advantages. The gas is heavier than air, its preservative property is great, the smell not too repulsive, and the insects are quickly stupefied and die without cramp, so that all muscles are relaxed and the dead insect accordingly easy to set. It is a common objection that insects caught in this trap are rather torn, but as a rule they will be less damaged than in a hand-net.

Different kinds of insects act very differently after entering the trap. Most *Diptera* and many *Hymenoptera* go straight up through the openings and enter the cylinder with very little hesitation, and the same can be said of the night-moths (*Noctuidae*) and hawk-moths (*Sphingidae*). *Coleoptera* usually settle on the netting and climb up to the inner parts of the trap, but some of them first fall to the ground and start the climb from there. Large dragon-flies (*Odonata*) are more rarely caught in the trap, as after entering they usually turn back again the way they came. *Rhopalocera* sometimes stay for a comparatively long time in the last compartment before venturing to enter the cylinder. Although the trap was specially designed for flying insects, many wingless ones climb the netting from the ground and are caught. In Burma I don't think there was a single time I sorted up the days catch without finding a considerable number of spiders, millipedes, ants, and so on, and on a wet place near a rivulet I persistingly got crabs in the trap, until by means of twigs I elevated the lower borders of the netting above the ground. Those crabs were most annoying; because before dying they crawled around on the bottom of the cylinder, spitting out so much water, that the insects already caught were transformed into a useless dough.

The original model of the trap had some drawbacks. First, it was only unilateral. Except that insects could only enter from one direction, the top of the trap with the cylinder was only on the right side (all my traps were copied from one specimen and accordingly identical). In broken country it is most advantageous to have the cylinder on the hill-side, as otherwise very long poles are required, and it is inconvenient to empty the cylinder when high up. Suitably growing trees are rarely to be found except on the hill-side, and very often it would therefore have been desirable to have the cylinder on the opposite side. I have now constructed traps with entrances from both sides (Fig. 5, 6, and 9), which accordingly may be turned with the cylinder on the desirable side.

In the original trap the entrance to the cylinder was only about 3 cm. in diameter. This caused many insects to hesitate to enter, but once through they could never find the way back again. In newer models this opening has been enlarged to 7 or 10 cm. It is probable that a few insects may find their way back from the cylinder with so large an opening, but it is likely that they will soon return again. Too large an opening may always be partly blocked up if necessary; but one too small one is impossible to

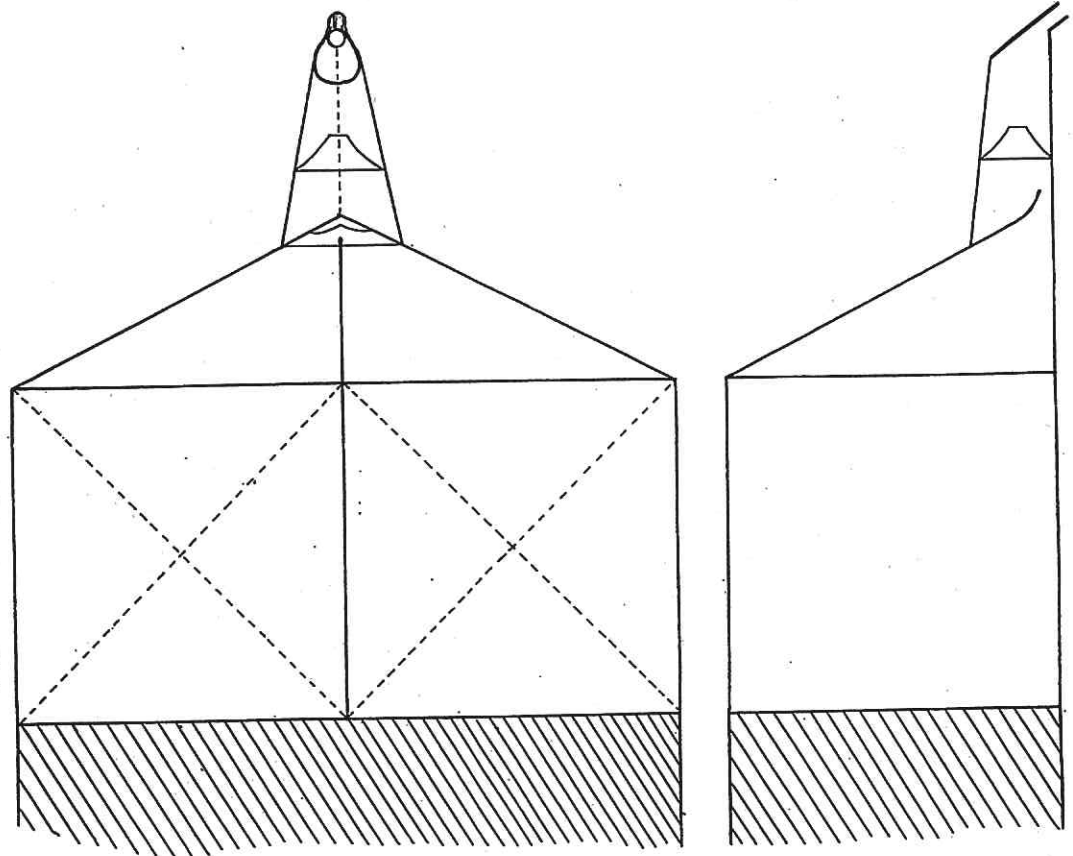

Fig. 5. The bilateral trap. a) Lateral view. b) From in front.

change. On the old model the apex of the pyramidal upper compartment close before the entrance to the cylinder was apt to fall in or collapse, and therefore some insects never entered the cylinder, but died in some corner of the netting or ate their way out of it. In newer models the netting before the entrance to the cylinder is spread out by a frame-work of brass tubes.

In the original model, and also in the first bilateral one, the depth of the main part of the trap on each side was equal to its width (Fig. 3 and 5). The advantage of this is that insects entering will not so easily find their way back again, but it requires great quantities of the netting fabric. If the entrance chambers were

made only half as deep, the same amount of netting fabric as in the bilateral trap would be enough for another bilateral one of twice the width (Fig. 6). In this case the cylinder has to be attached to the middle and lowered when emptied. No doubt many insects will turn back from the main wall and escape owing to the lesser depth, but, as this wall is twice as large as the original one and accordingly more insects enter, it is likely that the ultimate result will be better. If made with the usual width of 2 yards (Fig. 9 d) no more netting is required than for the

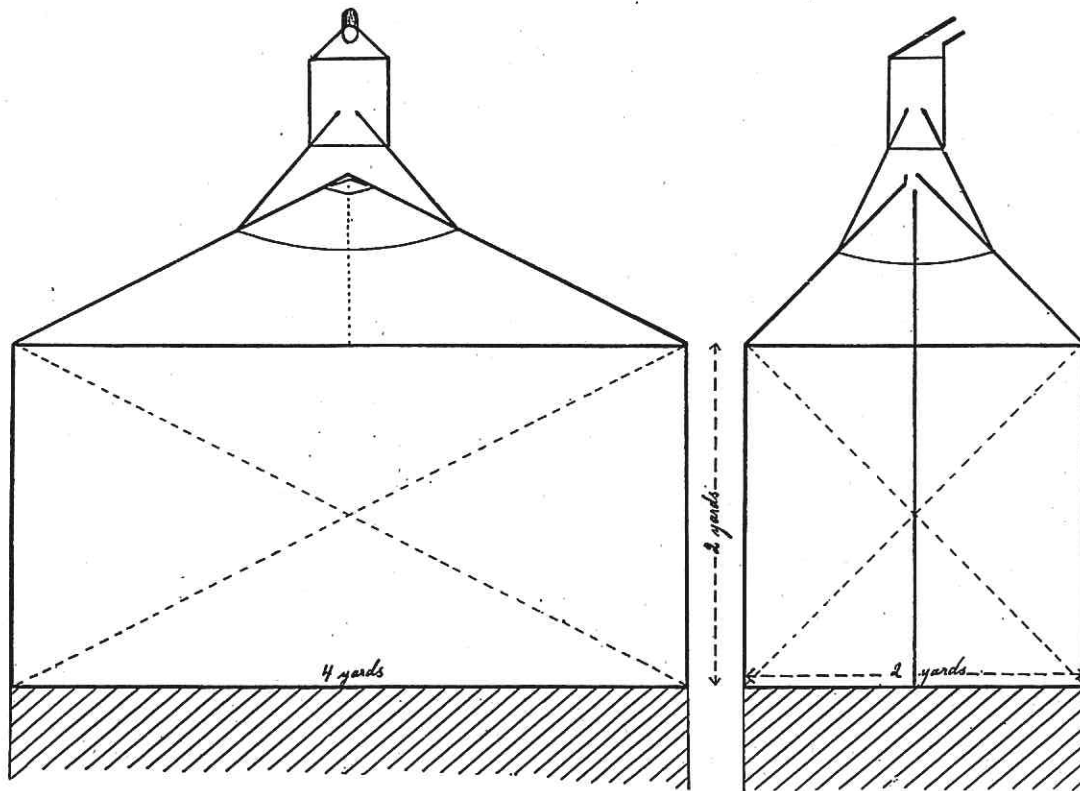

Fig. 6. The second bilateral trap. a) From in front. b) Lateral view.

original model. In this last case the cylinder can be placed on one side, and accordingly only one long pole is required for pitching. These two latter models are also more easy and economical in construction, as the fabric may be cut with practically no waste (Fig. 7).

When cutting the netting it has proved practical to stretch the fabric with drawing-pins on a floor, cut it along chalked lines, and, while the pieces are still attached to the floor to have cottonbands basted along all the borders. An attempt to baste the bands on the netting without such aid will certainly result in the netting being unequally stretched, and in the different pieces not fitting. It is quite essential that the netting in all seams be sewn between two bands.

When two pieces are to be connected it is advisable to baste the netting of one piece to half the width of one of the bands, and then baste the other band to the other piece, so that when the two pieces are sewn together with a sewing-machine the bands are on opposite sides with the netting between them. As the netting is apt to stretch, it is advisable to reinforce the larger sides from the corners with bands.

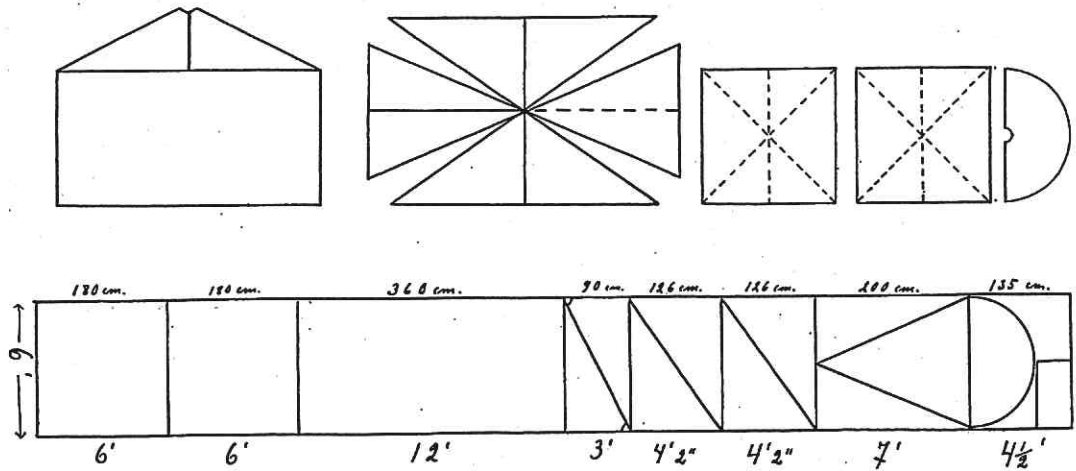

Fig. 7. How to cut the netting for the traps of fig. 6; 9 c, and also 9 d.

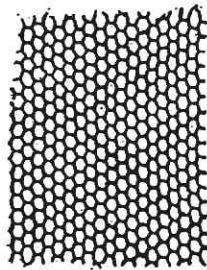

Fig. 8. Sample of the netting (actual size).

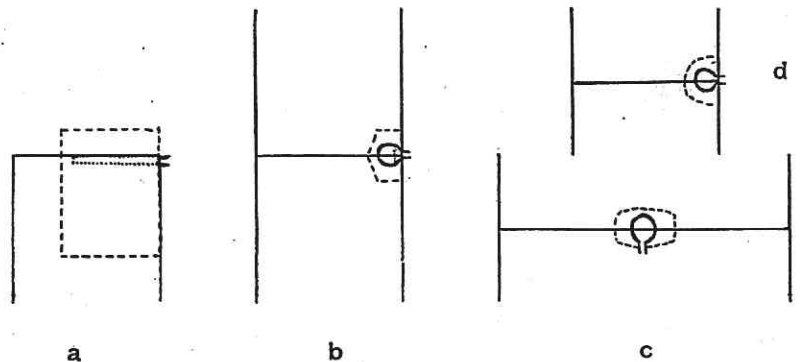

Fig. 9. Plan of the different models.

The netting is of black cotton (Fig. 8). This netting fabric is sold in width of one or two yards and the price is approximately one shilling a square-yard. For seams and reinforcement $\frac{3}{4}$ inch wide cotton bands are used; the price is about 7 shillings for a roll of 100 metres. The cylinders are made of hard-rolled brass sheet, 0,2 mm. thick. This is sold in the shape of bands one foot wide.

As mentioned above, this trap was originally designed for use in an entomological expedition to Burma, but later on it has been successfully used in the island of Madeira, in arctic Lappland, and in the suburbs of Stockholm. Only traps that have en-

s in
e of
be
oubt
ape
the
that
idth
the

on
ing.
l in
aste

the
nd,
nds
the
un-
uite
ids.

dured tropical sun and rains for several months before and after the break of the monsoon and are still serviceable, have been used. No bilateral models have as yet been tried, but they can hardly be less effective.

One of the advantages of this trap is that it may stay unattended for several days. This makes it most valuable for the study of the insect-fauna in places difficult of access, e.g. high mountains, swamps, islands, etc. In dense tropical woods of the low-land certain insects live in the tree-tops and are accordingly inaccessible to the ordinary entomologist, but to suspend a large trap up there ought not to be impossible. The forests are crossed by streams and narrow rivers, and even if some of them are quite overgrown a depression in the upper surface of the dense foliage will mark their direction and provide places for a trap. The tropical woods are composed of a multitude of different kinds of trees, and some of them are real giants with their crowns soaring high above the tops of their fellow-trees. It will be a difficult but not impossible task to find two such giants growing fairly close together and preferably on opposite shores of such a river. From a rope stretched between the two tree-tops a trap might be suspended at the desired height in mid air from blocks, preferably movable along the rope to ensure the best position. For such a purpose the large bilateral trap (Fig. 6) should be best. By means of a framework attached to the corners of the ceiling and weights at the lower brim, the trap may be hung, and the whole be lowered for emptying by means of ropes and blocks. In some places, e.g. the Amazonas, some precautions must be taken to prevent apes from destroying the traps, and even in ordinary places and on the ground it is advisable to fence in the traps for protection against cattle, wild animals, and people.

For students interested in a statistical survey of the insect-fauna of a particular region, this trap may prove most useful, and it is possible that it might also be used with success in orchards to decimate insect-pests.

The use of insect-traps in a country rich in insects will raise the problem of taking care of the catch. The immediate pinning or setting of the insects is always the best, but with the quantities furnished by only a few traps a multitude of preparators would be required. I am myself working on *Hymenoptera Tenthredinidae*, and, when in Burma, I sorted out all the saw-flies from the catch and pinned them, but the rest also required attention. All *Lepidoptera* were sorted out and dried in covers. *Coleoptera* and *Hemiptera* were put in air-tight bottles and mixed with moist sawdust and a few drops of acetic ether; a very good and simple method that keeps the insects soft and ready for immediate setting

as long as the moisture and the acetic ether remain. For preserving the remaining collection of different insects I had brought along strong glass-tubes open at both ends (Fig. 10). I had two sizes, the larger 120 mm. long and 27—30 mm. inner diameter, the smaller 100 by 20 mm. On the inside at each end of the tubes a round spring was inserted, made of cuttings of a brass-tube of somewhat lesser diameter than the glass tube. These springs held a piece of chiffon, an extremely fine and loose material, stretched like a wall. The glass-tubes were stuffed with a mass of newly killed insects. By successively tilting the tube from one side to the other the right consistence is obtained, neither too

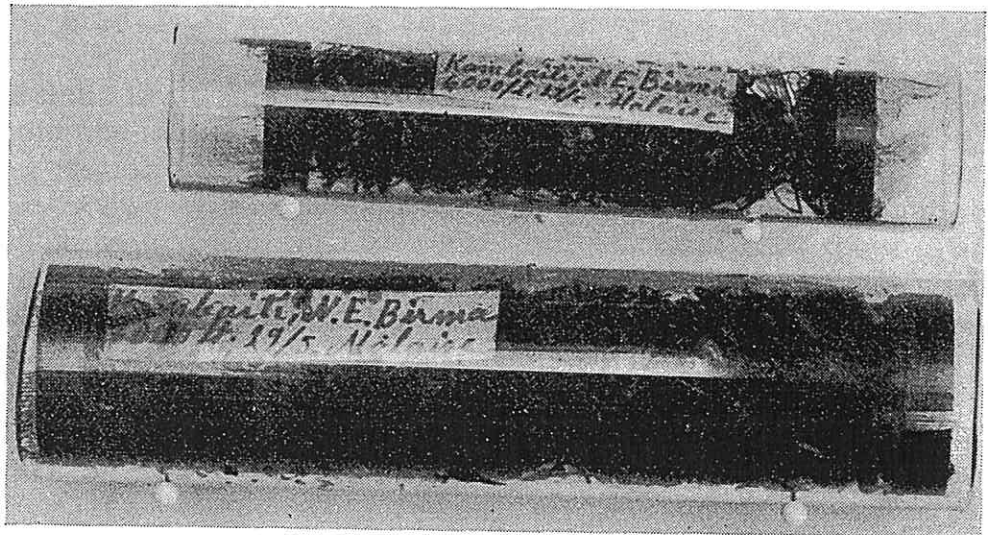

Fig. 10. Glasstubes packed with dried insects. (Somewhat reduced.)

compressed nor too loose, only just enough for the insects to keep each other in place. The springs with the chiffon are thereby alternately pressed closer and closer to the content. Then the tube must be dried in an airy and shady place. The air with the moisture from the insects can easily pass through the chiffon and the process of drying may be examined through the glass. When thoroughly dry the tubes may lie for an hour or so exposed to the sun, and then be packed up in tins. If the tubes are exposed to the sun before the content is dry, the moisture will condense on the inside of the tube and soak the insects.

By this method a multitude of different insects can be transported in comparative safety, without danger of their being damaged by careless fingers, as very often happens if the insects are kept in paper-tubes, and the content may at any moment be seen through the glass. The chiffon and the spring may be exchanged for a piece of the finest wire netting pressed in the form of a

shallow cup with a flat bottom and fitting the inside of the tube. This will protect the insects when drying from the attack of minute ants, that otherwise may eat a hole in the chiffon and spoil the contents. During the rains, the drying of the tubes had to be performed over a lamp or stove. Although I had taken along a very good supply of glass tubes to Burma I became short of them, and had then to put the insects in ordinary but rather large cigarette boxes. This method also proved to be a good one, and the quality of the content was better than was expected.
